

VERSIONE ALTA-BASSA FIAMMA "AB" / PROGRESSIVO "PR"
 "AB" HIGH-LOW / "PR" PROGRESSIVE VERSION

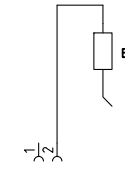
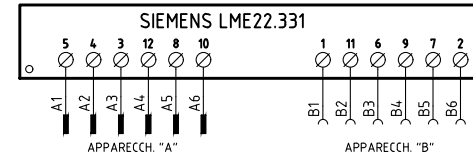
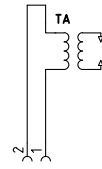
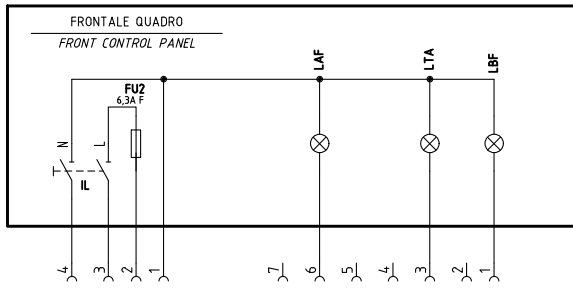

SERVOCOMANDO SERRANDA ARIA
 AIR DAMPER ACTUATOR
 STA4.5B... (AB) - STA 13B... (PR - MD)

I ALTA FIAMMA
 HIGH FLAME
 II (BLU) SOSTA
 STAND-BY
 III (ARANCIO) BASSA FIAMMA
 LOW FLAME
 IV (NERO) NON USATA
 NOT USED

SERVOCOMANDO SERRANDA ARIA
 AIR DAMPER ACTUATOR
 SQN72.xA4.A20

I (ROSSO) ALTA FIAMMA
 HIGH FLAME
 II (BLU) SOSTA
 STAND-BY
 III (ARANCIO) BASSA FIAMMA
 LOW FLAME
 IV (NERO) NON USATA
 NOT USED

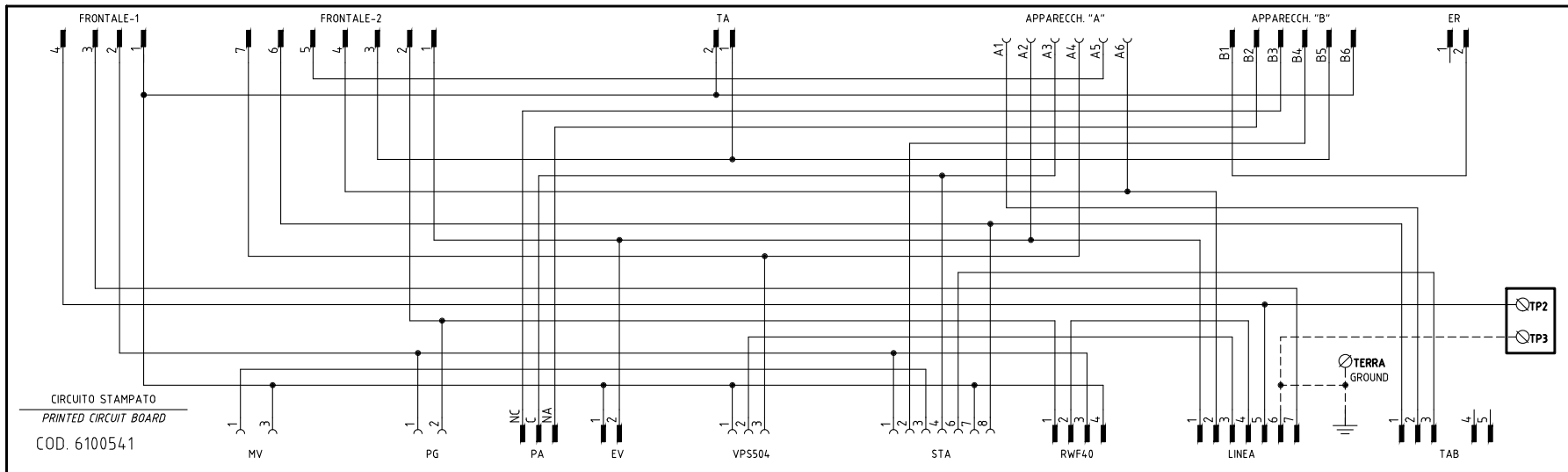

COD. 6100541

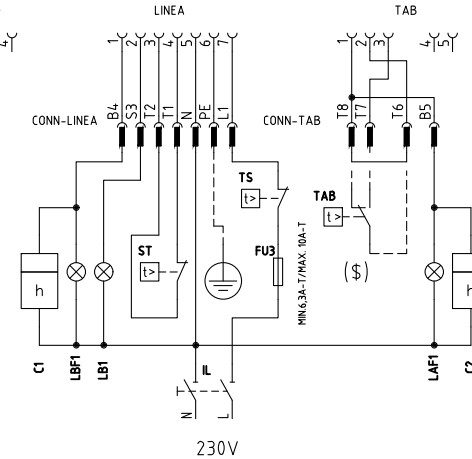
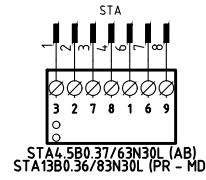
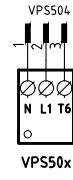
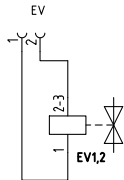
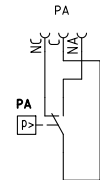
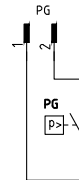
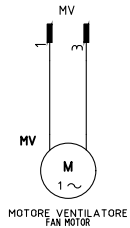

(x x x) SOLO CON ALIMENTAZIONE ELETTRICA SENZA NEUTRO
 WITH ELECTRIC SUPPLY WITHOUT NEUTRAL VERSION ONLY

(\$) SE USATO "TAB", TOGLIERE IL PONTE TRA I MORSETTI [T6-T8]
 IF USED "TAB", REMOVE THE BRIDGE BETWEEN TERMINALS [T6-T8]



Impianto
 TIPI/TYPES NG/LG 140 - 200 / NGX120 - 200
 MODELLO/MODEL x-.AB(PR)(MD).x.xx.A.1.xx

Descrizione
 VERSIONE CON CIRCUITO STAMPATO
 WITH PRINTED CIRCUIT VERSION

Ordine
 Commessa
 Esecutore
 U. PINTON

Data Controllato
 22/10/2018

Controllato
 M. MASCHIO

Data 22/10/2018
 Revisione 00
 Dis. N. 18 - 0323

PREC. /
 FOGLIO 1
 SEQUE 2
 TOTALE 4

VERSIONE MODULANTE "MD"
 "MD" MODULATING VERSION

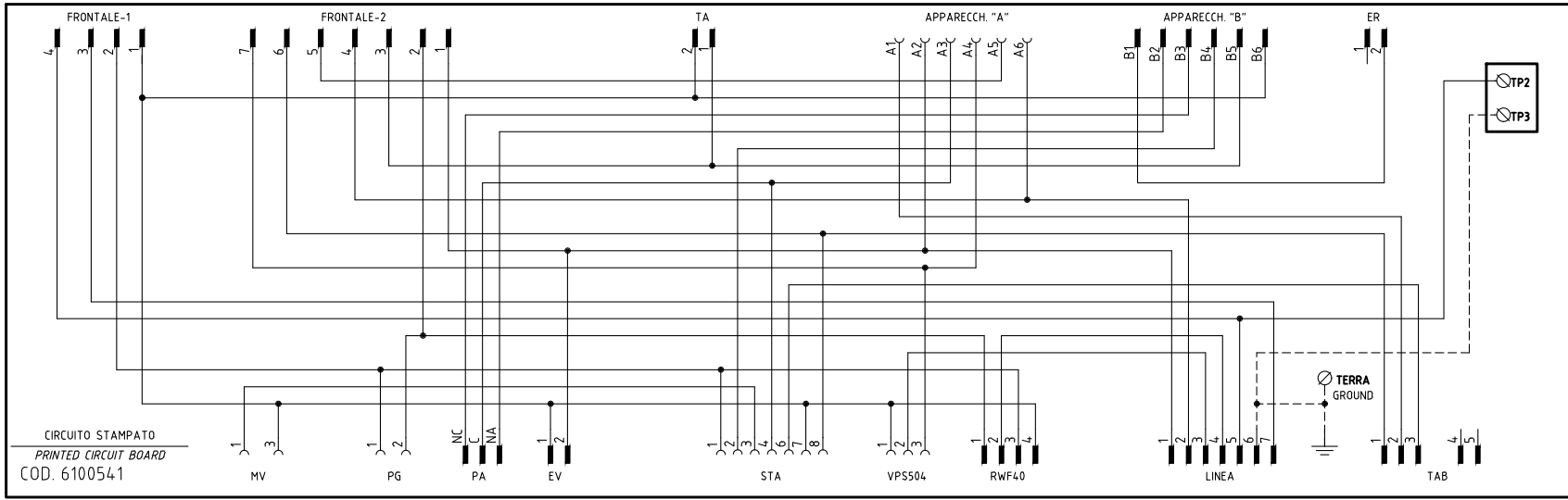
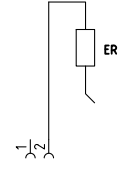
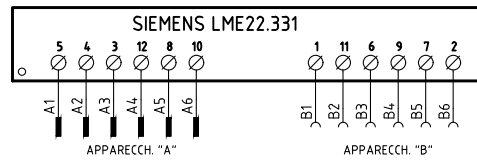
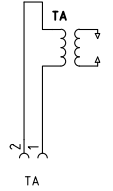
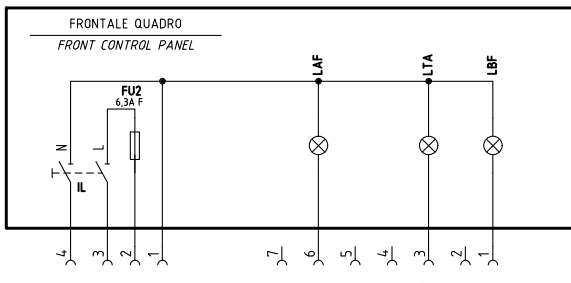

CIRCUITO STAMPATO
 PRINTED CIRCUIT BOARD
 COD. 6100541

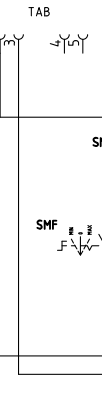
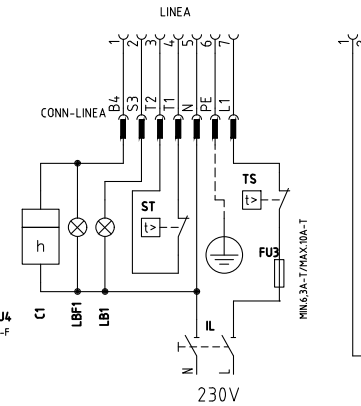
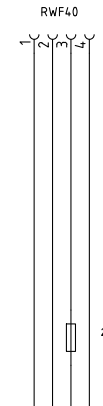
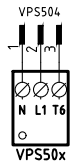
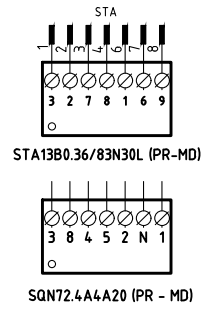
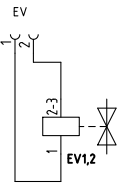
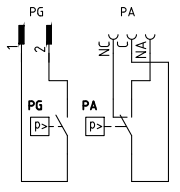
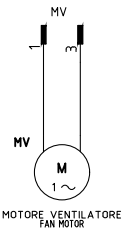

ASCON KM3 HCRMMD	14 12 7 8 10 9 11-13	4	1	2	3		
600V RRR0-1-T73 (S)	20 6 21 22 23 24 19-5	4	3	2	1		
SIEMENS RWF50.2x	K2 K3 IN IP L1 N KQ	G-	G+	13	12	11	
SIEMENS RWF4.0x0	Y1 Y2 Q13Q14 L1 N Q TE	U1	G-	G+	M1	I1	G+
SIEMENS RWF55.5x	K2 K3 IN IP L1 N KQ TE	13	G-	G+	14	12	11

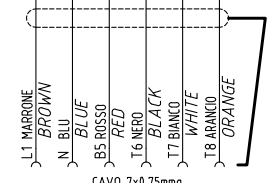

CAVO 7x0,75mmq
 7x0,75mmq CABLE
 CONN. SONDE

(x x)
 COLLEGAMENTO SONDE
 PROBE CONNECTION

SERVOCOMANDO SERRANDA ARIA
 AIR DAMPER ACTUATOR
 STA13B0.36/83N30L (PR - MD)
 I ALTA FIAMMA HIGH FLAME
 II SOSTA STAND-BY
 III BASSA FIAMMA LOW FLAME
 IV NON USATA NOT USED

SERVOCOMANDO SERRANDA ARIA
 AIR DAMPER ACTUATOR
 SQN72.4A4.A20 (PR - MD)
 I (ROSSO) ALTA FIAMMA HIGH FLAME
 II (BLU) SOSTA STAND-BY
 III (ARANCIO) BASSA FIAMMA LOW FLAME
 IV (NERO) NON USATA NOT USED

(x x) SOLO CON ALIMENTAZIONE ELETTRICA SENZA NEUTRO
 WITH ELECTRIC SUPPLY WITHOUT NEUTRAL VERSION ONLY

Data	22/10/2018	PREC.	FOGLIO
Revisione	00	1	2
Dis. N.	18 - 0323	SEGUE	TOTALE
		3	4

(xx) ATTENZIONE COLLEGAMENTO SONDE CON CONNETTORE 7 POLI
 WARNING PROBE CONNECTION WITH 7 PINS CONNECTOR
RWF55.5x **RWF50.2x** **RWF40.0xx**

KM3 HCRMMD

600V RRR0-1-T73

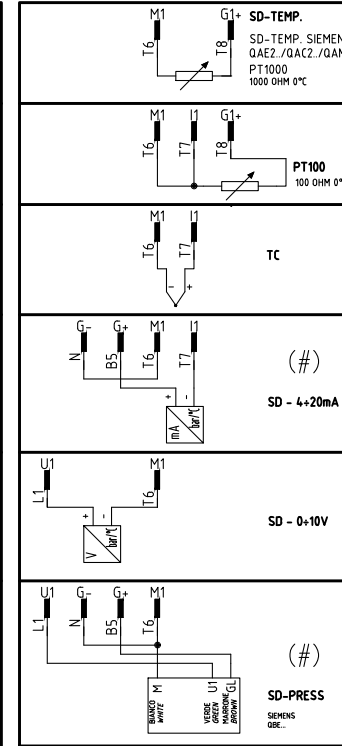
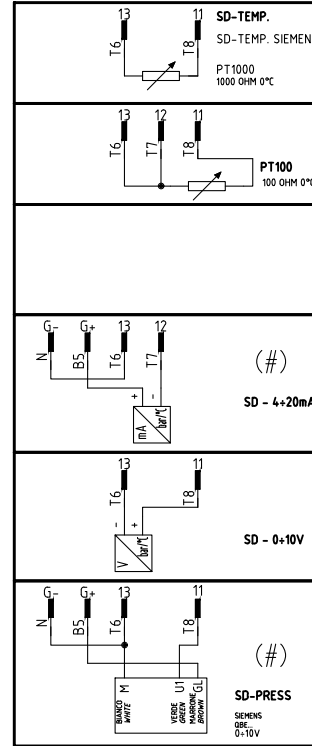
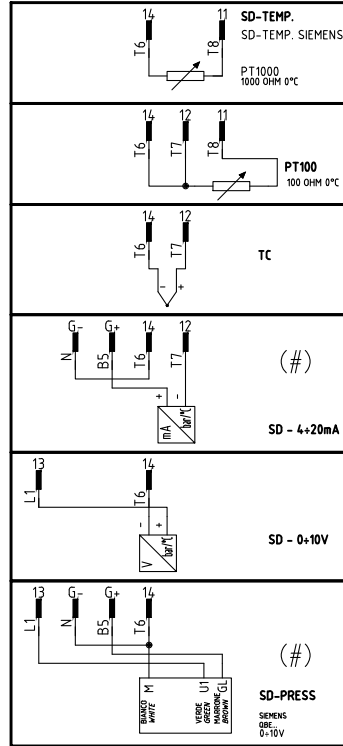
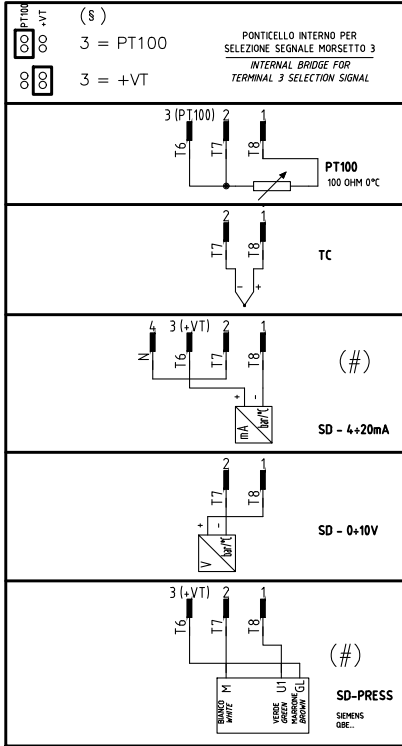
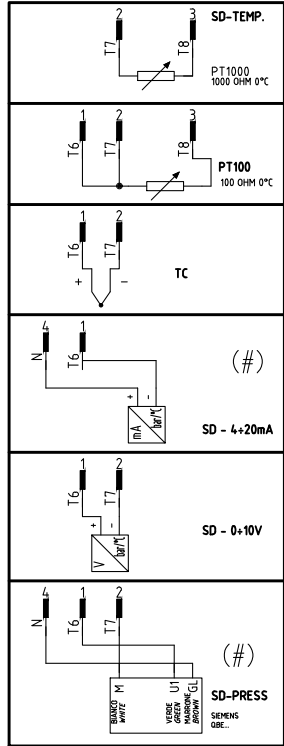

(#)
 COLLEGAMENTO SOLO PER
 TRASDUTTORI PASSIVI
 TRANSDUCER PASSIVE
 CONNECTION ONLY

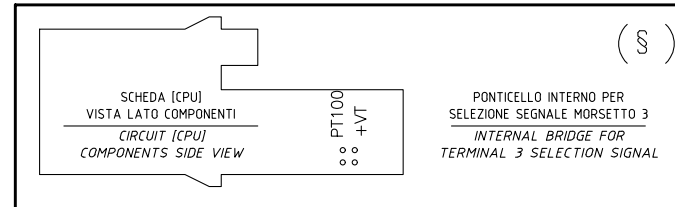
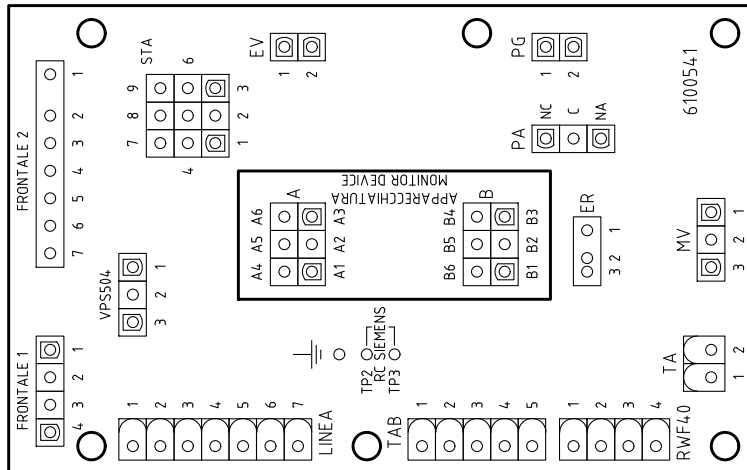

Data	22/10/2018	PREC.	FOGLIO
Revisione	00	2	3
Dis. N.	18 - 0323	SEGUE	TOTALE
		4	4

Sigla/Item	Funzione	Function
600V RRR0-1-T73	REGOLATORE MODULANTE (ALTERNATIVO)	BURNER MODULATOR (ALTERNATIVE)
C1	CONTAORE BASSA FIAMMA	LOW FLAME TIME COUNTER
C2	CONTAORE ALTA FIAMMA	HIGH FLAME TIME COUNTER
ER	ELETTRODO RILEVAZIONE FIAMMA	FLAME DETECTION ELECTRODE
EV1,2	ELETTROVALVOLE GAS (O GRUPPO VALVOLE)	GAS ELECTRO-VALVES (OR VALVES GROUP)
FU2	FUSIBILE DI LINEA	LINE FUSE
FU3	FUSIBILE DI LINEA	LINE FUSE
FU4	FUSIBILE AUSILIARIO	AUXILIARY FUSE
IL	INTERRUTTORE LINEA BRUCIATORE	BURNER LINE SWITCH
KM3 HCRMMD	REGOLATORE MODULANTE (ALTERNATIVO)	BURNER MODULATOR (ALTERNATIVE)
LAF	LAMPADA SEGNALAZIONE ALTA FIAMMA BRUCIATORE	BURNER IN HIGH FLAME INDICATOR LIGHT
LAF1	LAMPADA SEGNALAZIONE ALTA FIAMMA BRUCIATORE	BURNER IN HIGH FLAME INDICATOR LIGHT
LB1	LAMPADA SEGNALAZIONE BLOCCO BRUCIATORE	INDICATOR LIGHT FOR BURNER LOCK-OUT
LBF	LAMPADA SEGNALAZIONE BASSA FIAMMA BRUCIATORE	BURNER IN LOW FLAME INDICATOR LIGHT
LBF1	LAMPADA SEGNALAZIONE BASSA FIAMMA BRUCIATORE	BURNER IN LOW FLAME INDICATOR LIGHT
LTA	LAMPADA SEGNALAZIONE TRASFORMATORE DI ACCENSIONE	IGNITION TRANSFORMER INDICATOR LIGHT
MV	MOTORE VENTILATORE	FAN MOTOR
PA	PRESSOSTATO ARIA	AIR PRESSURE SWITCH
PG	PRESSOSTATO GAS DI MINIMA PRESSIONE	MINIMUM GAS PRESSURE SWITCH
PT100	SONDA DI TEMPERATURA	TEMPERATURE PROBE
RC	CIRCUITO RC	RC CIRCUIT
SD-PRESS	SONDA DI PRESSIONE	PRESSURE PROBE
SD-TEMP.	SONDA DI TEMPERATURA	TEMPERATURE PROBE
SD - 0÷10V	TRASDUTTORE USCITA IN TENSIONE	TRANSDUCER VOLTAGE OUTPUT
SD - 4÷20mA	TRASDUTTORE USCITA IN CORRENTE	TRANSDUCER CURRENT OUTPUT
SIEMENS LME22.331	APPARECCHIATURA CONTROLLO FIAMMA	CONTROL BOX
SIEMENS RWF4.0.0x0	REGOLATORE MODULANTE	BURNER MODULATOR
SIEMENS RWF50.2x	REGOLATORE MODULANTE	BURNER MODULATOR
SIEMENS RWF55.5x	REGOLATORE MODULANTE (ALTERNATIVO)	BURNER MODULATOR (ALTERNATIVE)
SIEMENS SQN72.xA4A20	SERVOCOMANDO SERRANDA ARIA (ALTERNATIVO)	AIR DAMPER ACTUATOR (ALTERNATIVE)
SMA	SELETTORE MANUALE/AUTOMATICO	MANUAL/AUTOMATIC SWITCH
SMF	SELETTORE MANUALE FUNZIONAMENTO MIN-0-MAX	MIN-0-MAX MANUAL OPERATION SWITCH
ST	SERIE TERMOSTATI/PRESSOSTATI	SERIES OF THERMOSTATS OR PRESSURE SWITCHES
STA4.5B... / STA13B...	SERVOCOMANDO SERRANDA ARIA	AIR DAMPER ACTUATOR
TA	TRASFORMATORE DI ACCENSIONE	IGNITION TRANSFORMER
TAB	TERMOSTATO/PRESSOSTATO ALTA-BASSA FIAMMA	HIGH-LOW THERMOSTAT/PRESSURE SWITCHES
TC	TERMOCOPPIA	THERMOCOUPLE
TS	TERMOSTATO/PRESSOSTATO DI SICUREZZA	SAFETY THERMOSTAT OR PRESSURE SWITCH
VPS50x	CONTROLLO DI TENUTA VALVOLE GAS	GAS PROVING SYSTEM

Data	22/10/2018	PREC.	FOGLIO
Revisione	00	3	4
Dis. N.	18 - 0323	SEGUE	TOTALE
		/	4