

(x)
 INSTALLATO SOLO SU ALCUNE VERSIONI
 INSTALLED ON ANY VERSIONS ONLY

02	ADDED KA3.3 CONTACT	29/05/14	U. PINTON
01	MODIFIED MCX06C CONNECTION	05/02/13	U. PINTON
REV.	MODIFICA	DATA	FIRME



Impianto
TIPI/TYPES PBY70/÷/PBY520
MODELLO/MODEL H-.MD.x.xx.A. EA

Descrizione
VERSIONE CON LMV20 E REGOLAZIONE NAFTA
WITH LMV20 AND OIL REGULATION VERSION

Ordine
 Commessa
 Esecutore
 U. PINTON

Data Controllato
 05/02/2013

Controllato
 S. MARCHETTI

Data	12/07/2012	PREC.	FOGLIO
Revisione	02	/	1
Dis. N.	07 - 0518	SEQUE	TOTALE
		2	12

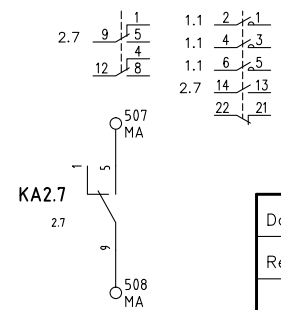
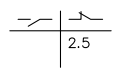
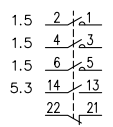
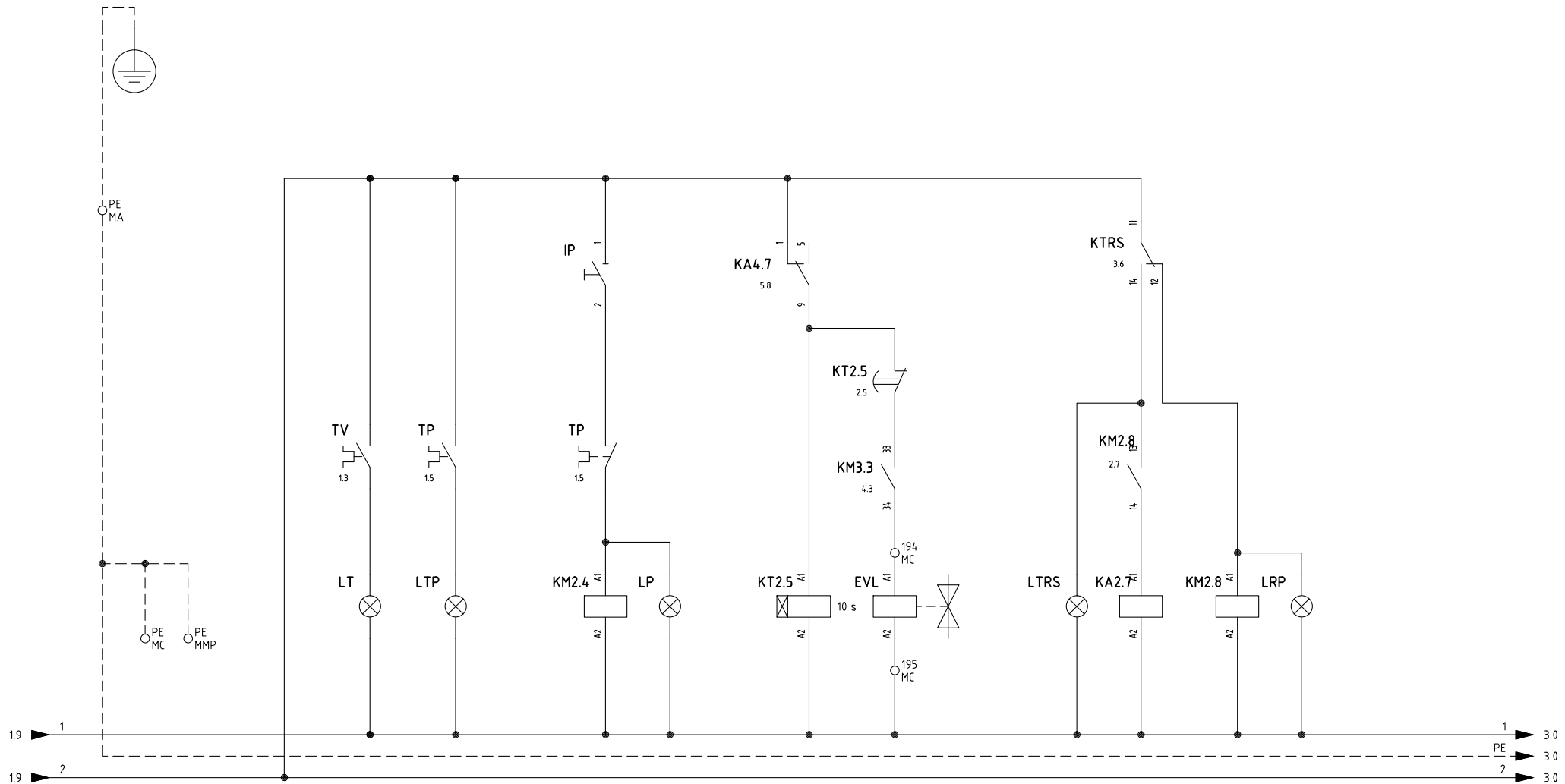

Data	12/07/2012	PREC.	FOGLIO
Revisione	02	1	2
Dis. N.	07 - 0518	SEGUE	TOTALE
		3	12

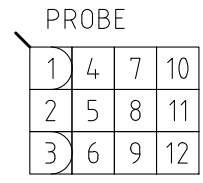
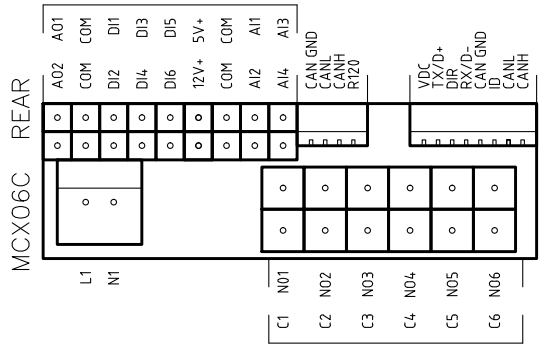
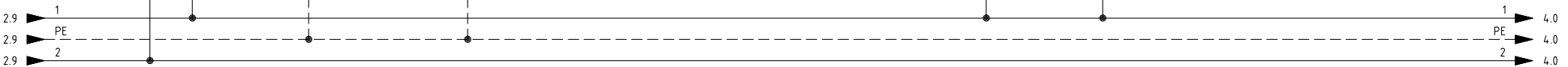
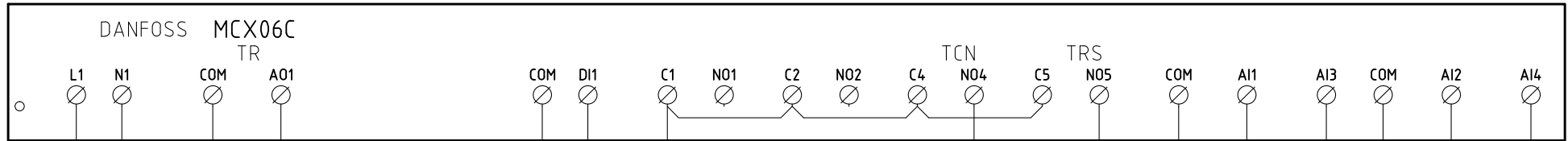

VISTA LATO COMPONENTI (SONDE)
COMPONENTS SIDE VIEW (PROBE)

Data	12/07/2012	PREC.	FOGLIO
Revisione	02	2	3
Dis. N.	07 - 0518	SEGUE	TOTALE
		4	12

SIEMENS
LMV20.100

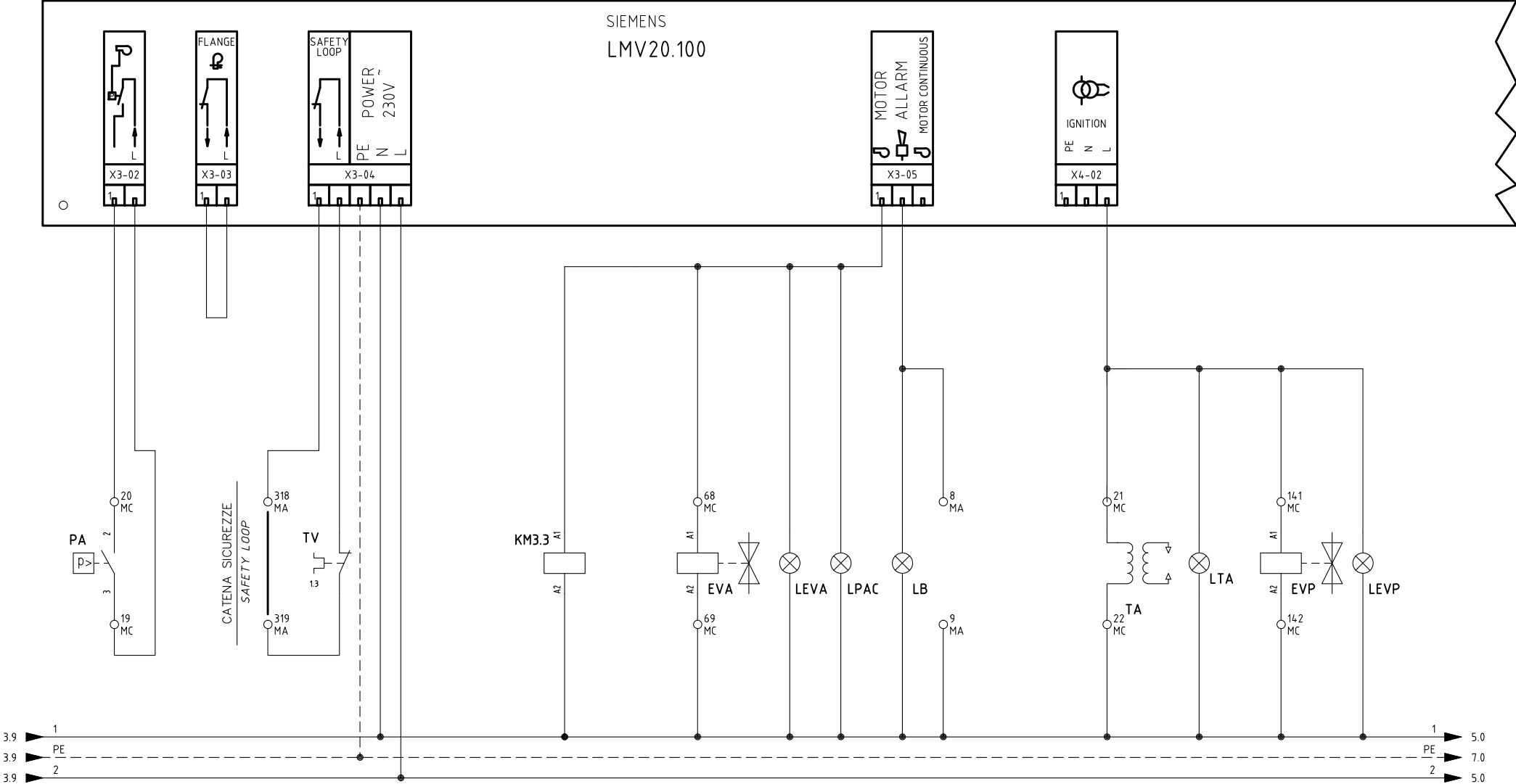

- 1.3 2 / a 1
- 1.3 4 / a 3
- 1.3 6 / a 5
- 5.2 14 / a 13
- 2.5 34 / a 33
- 22 / a 21

Data	12/07/2012	PREC.	FOGLIO
Revisione	02	3	4
Dis. N.	07 - 0518	SEGUE	TOTALE
		5	12

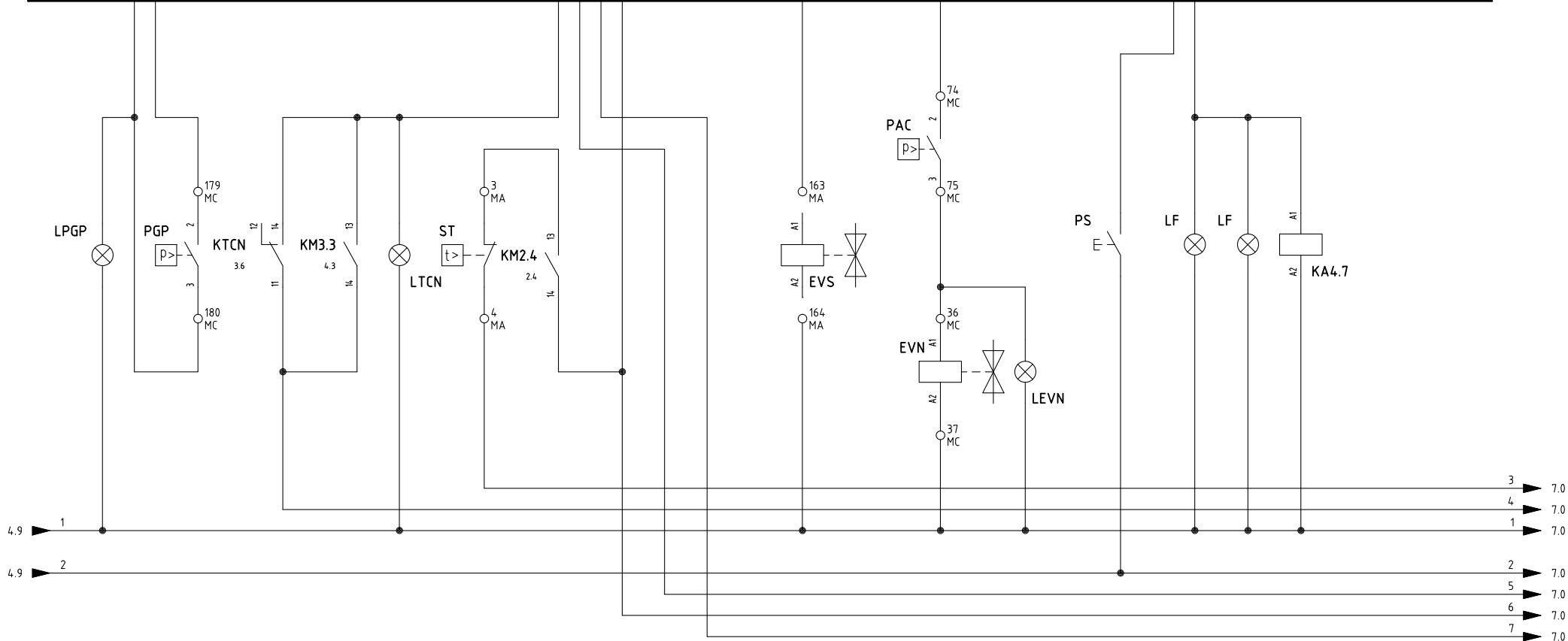
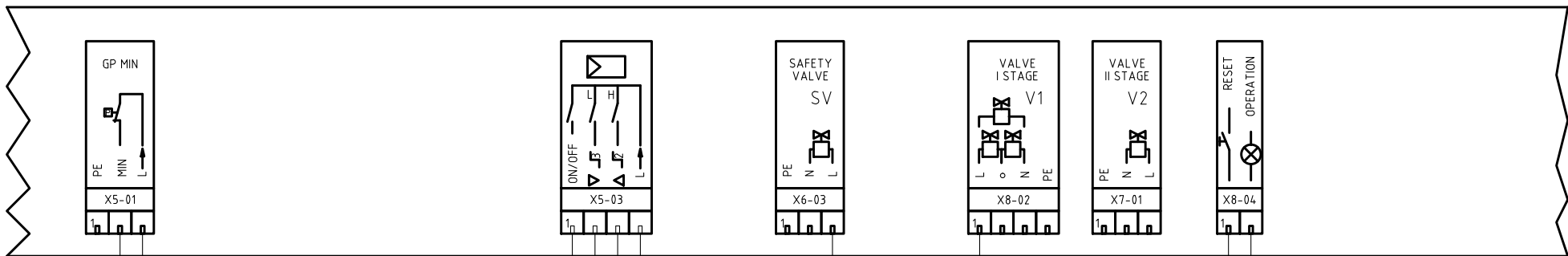

	1
2.5	9 5
	4
3.4	12 8

Data	12/07/2012	PREC.	FOGLIO
Revisione	02	4	5
Dis. N.	07 - 0518	SEGUE	TOTALE
		6	12

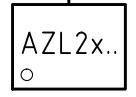
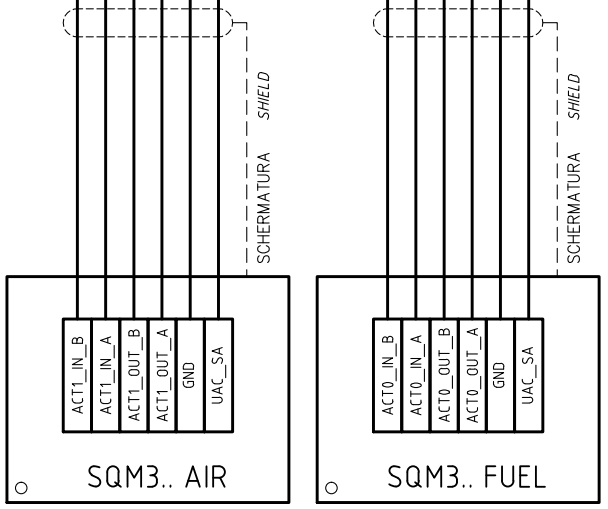
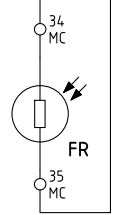
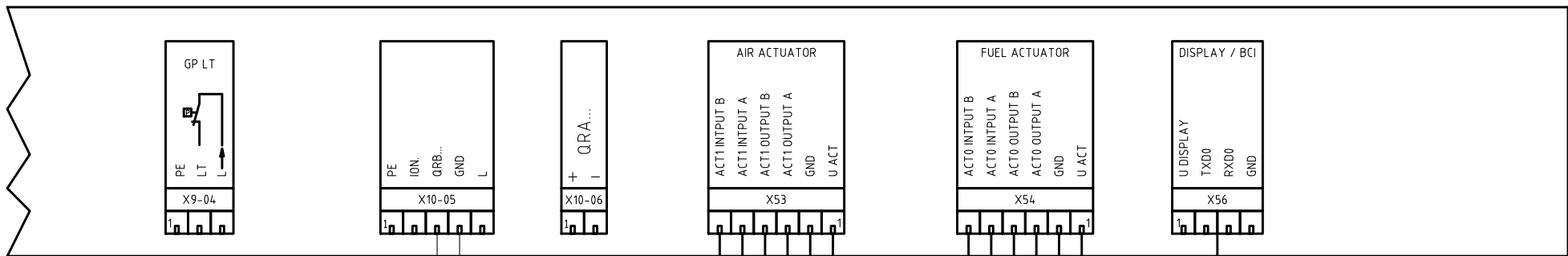

Data	12/07/2012	PREC.	FOGLIO
Revisione	02	5	6
Dis. N.	07 - 0518	SEGUE	TOTALE
		7	12

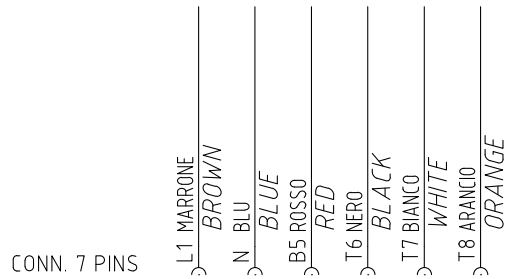
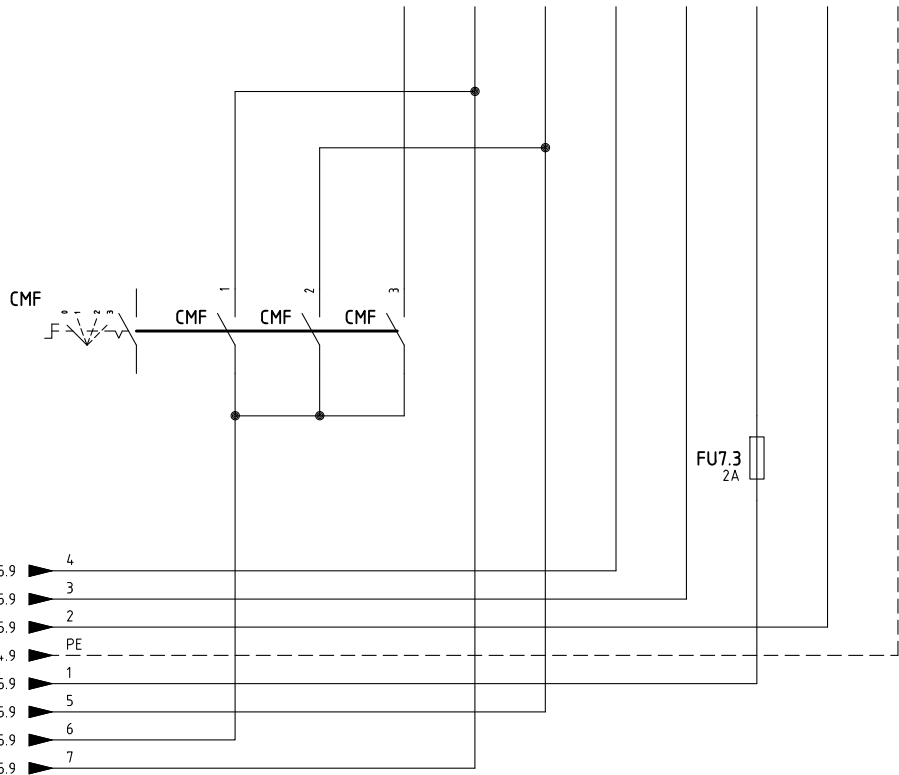
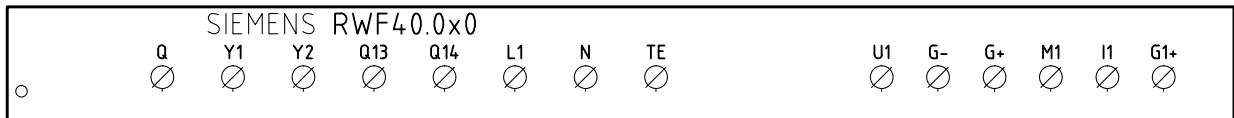
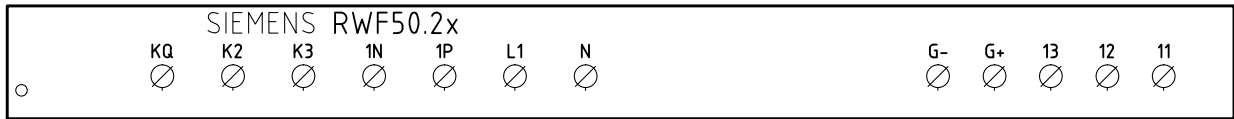
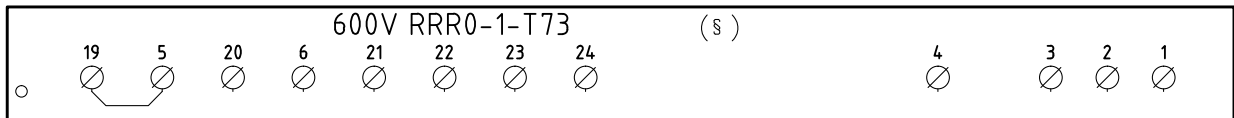

CAVO 7x0,75mmq
7x0,75mmq CABLE

(xx)
ATTENZIONE COLLEGAMENTO SONDE CON CONNETTORE 7 POLI
WARNING PROBE CONNECTION WITH 7 PINS CONNECTOR

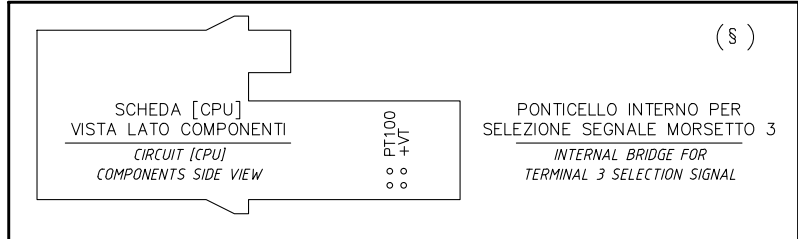

Data	12/07/2012	PREC.	FOGLIO
Revisione	02	6	7
Dis. N.	07 - 0518	SEGUE	TOTALE
		8	12

(xx)
 ATTENZIONE COLLEGAMENTO SONDE CON CONNETTORE 7 POLI
 WARNING PROBE CONNECTION WITH 7 PINS CONNECTOR

600V RRR0-1-T73

RWF40.0x0

RWF50.2x

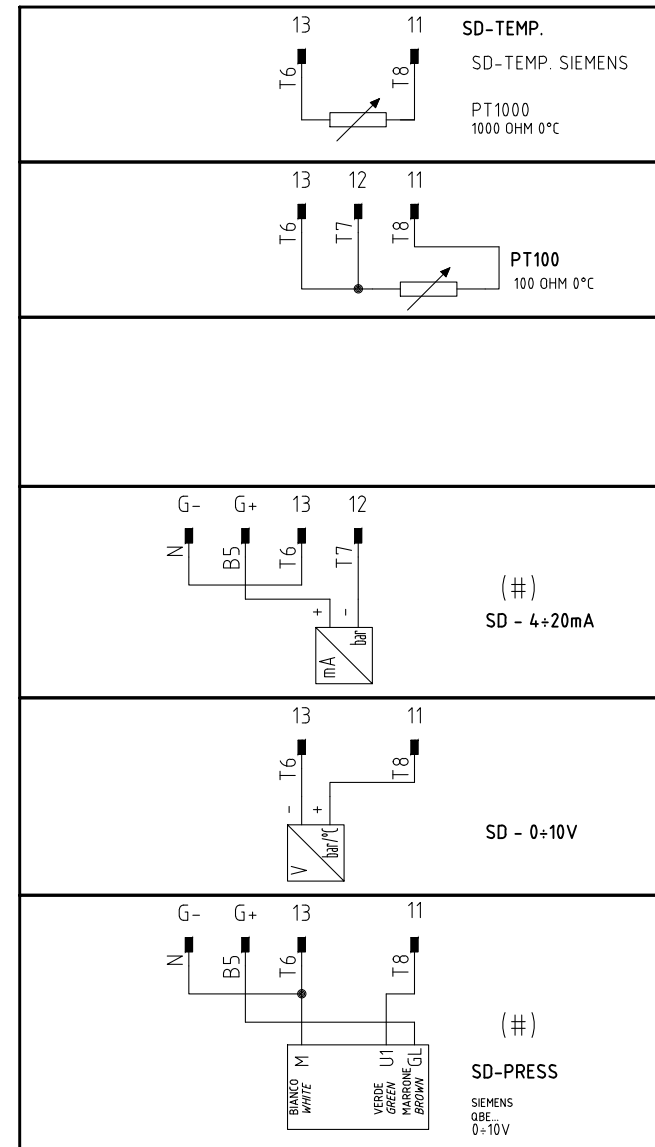
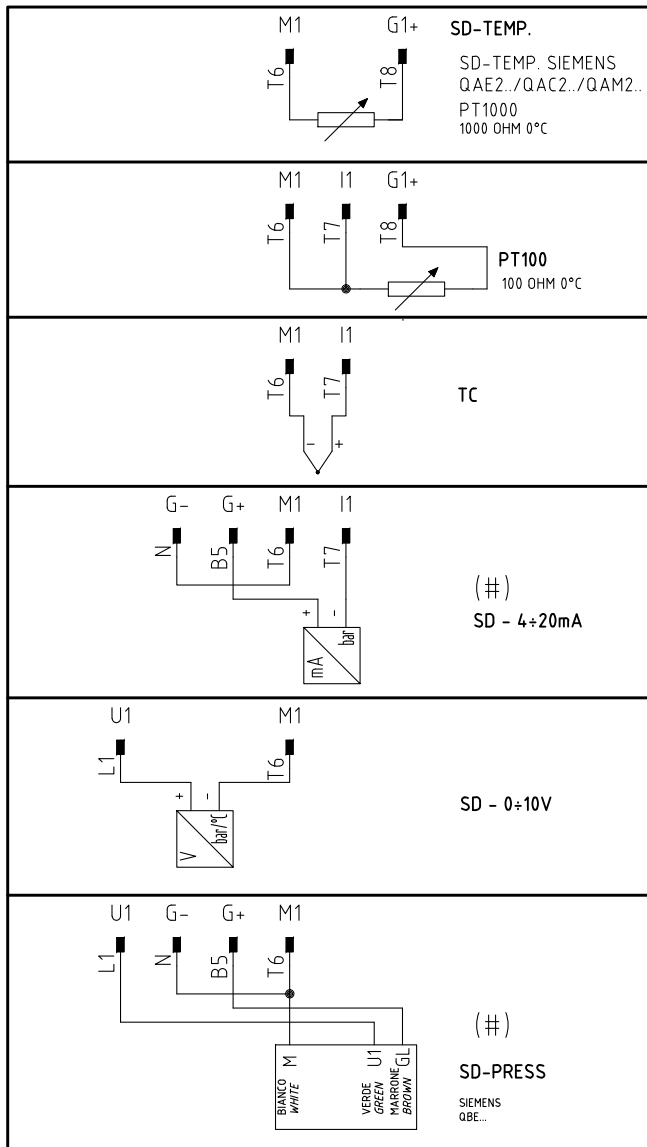
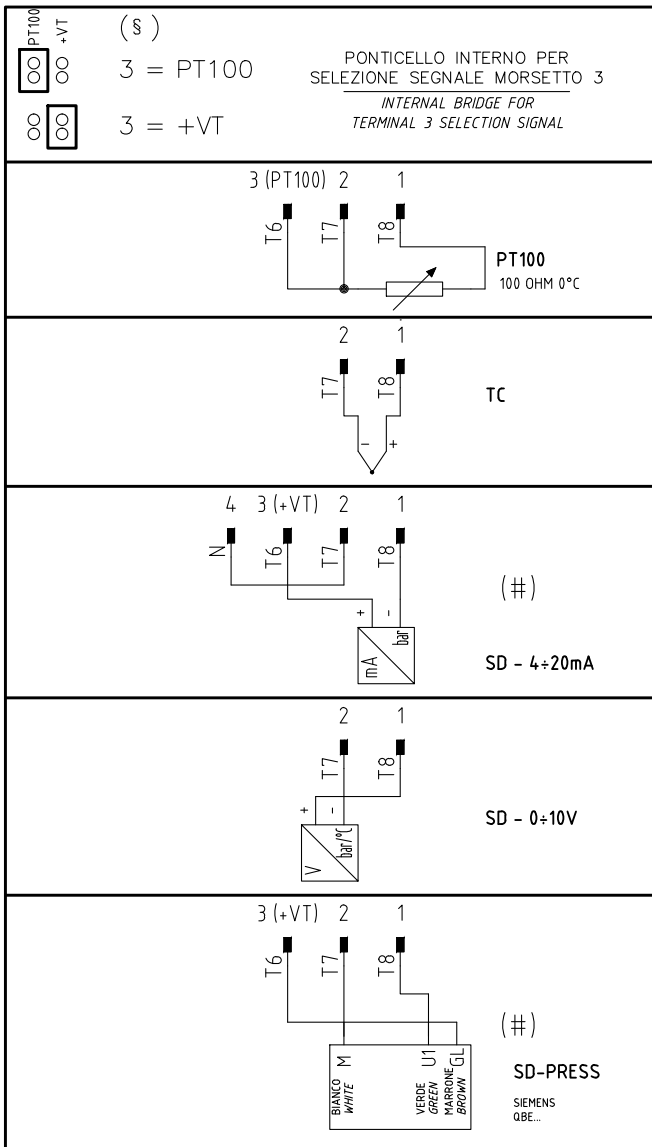

(#)
 COLLEGAMENTO SOLO PER
 TRASDUTTORI PASSIVI
 TRASDUCER PASSIVE
 CONNECTION ONLY

Data	12/07/2012	PREC.	FOGLIO
Revisione	02	7	8
Dis. N.	07 - 0518	SEGUE	TOTALE
		9	12

QUADRO QG - MORSETTIERA MMP
MORSETTIERA MOTORE POMPA
PUMP MOTOR TERMINAL BOARD

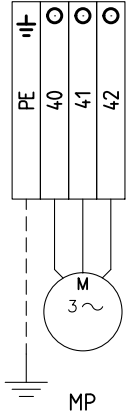

(x)

INSTALLATO SOLO SU ALCUNE VERSIONI
INSTALLED ON ANY VERSIONS ONLY

QUADRO QG - MORSETTIERA MA
MORSETTIERA ALIMENTAZIONE
SUPPLY TERMINAL BOARD

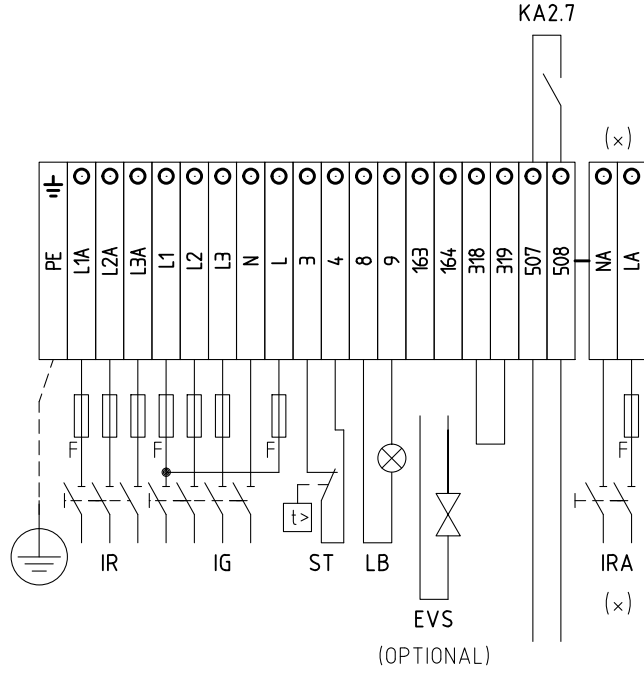

(OPTIONAL)

CATENA SICUREZZE
SAFETY LOOP

QUASTO CONTATTORE RESISTENZE
RESISTOR CONTACTOR FAILURE

QG - PROBE_F
CONNETTORE SONDE [MCX06C]
[MCX06C] PROBE CONNECTOR

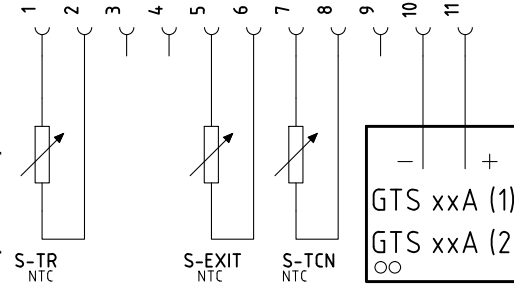

QUADRO QG - MORSETTIERA MC
MORSETTIERA COMPONENTI BRUCIATORE
BURNER COMPONENT TERMINAL BOARD

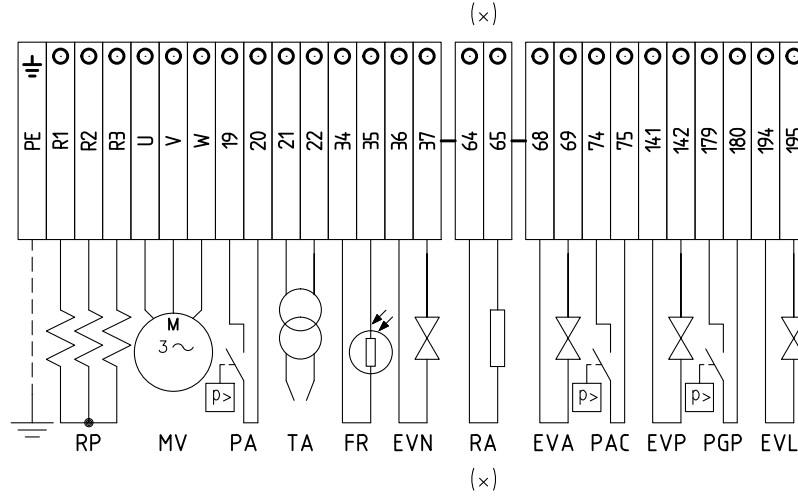

Data	12/07/2012	PREC.	FOGLIO
Revisione	02	8	9
Dis. N.	07 - 0518	SEGUE	TOTALE
		10	12

Sigla / Item	Foglio / Sheet	Descrizione	Description
600V RRR0-1-T73	7	REGOLATORE MODULANTE (ALTERNATIVO)	BURNER MODULATOR (ALTERNATIVE)
AZL2x..	6	INTERFACCIA UTENTE	USER INTERFACE
CMF	7	COMMUT. MANUALE FUNZ. 0)FERMO 1)ALTA FIAMMA 2)BASSA FIAMMA 3)AUTOMATICO	MANUAL SWITCH 0)OFF 1)HIGH FLAME 2)LOW FLAME 3)AUTOMATIC
EVA	4	ELETTROVALVOLA ARIA COMPRESSA	COMPRESSED AIR SOLENOID VALVE
EVL	2	ELETTROVALVOLA LAVAGGIO LANCIA	OIL GUN CLEAN SOLENOID VALVE
EVN	5	ELETTROVALVOLA NAFTA	OIL SOLENOID VALVE
EVP	4	ELETTROVALVOLA PILOTA GAS	PILOT GAS SOLENOID VALVE
EVS	5	ELETTROVALVOLA GAS DI SICUREZZA (OPTIONAL)	SAFETY GAS SOLENOID VALVE (OPTIONAL)
FR	6	FOTORESISTENZA RILEVAZIONE FIAMMA	PHOTORESISTOR FLAME DETECTOR
(x) FU1.0	1	FUSIBILE DI LINEA	LINE FUSE
(x) FU1.0A	1	FUSIBILE LINEA RESISTENZE AUSILIARIE	LINE AUXILIARY HEATERS FUSE
FU1.1	1	FUSIBILI LINEA PRERISCALDATORE RP	LINE PRE-HEATING RP FUSES
FU1.2	1	FUSIBILI LINEA MOTORE VENTILATORE	FAN MOTOR LINE FUSES
FU1.3	1	FUSIBILI LINEA POMPA	PUMP LINE FUSES
FU1.4	1	FUSIBILE LINEA AUSILIARI	AUXILIARY LINE FUSE
FU1.5	1	FUSIBILE LINEA AUSILIARI	AUXILIARY LINE FUSE
FU3.0	3	FUSIBILE AUSILIARIO	AUXILIARY FUSE
FU3.1	3	FUSIBILE AUSILIARIO	AUXILIARY FUSE
FU7.3	7	FUSIBILE	FUSE
GTS xxA (1)	3	TIRISTORE	THYRISTOR
GTS xxA (2)	3	TIRISTORE	THYRISTOR
IB	1	INTERRUTTORE LINEA BRUCIATORE	BURNER LINE SWITCH
IL	1	INTERRUTTORE LINEA AUSILIARI	AUXILIARY LINE SWITCH
IP	2	INTERRUTTORE POMPA NAFTA	OIL PUMP SWITCH
IR	1	INTERRUTTORE LINEA RESISTENZE PRERISCALDATORE	PRE-HEATING RESISTOR LINE SWITCH
(x) IRA	1	INTERRUTTORE RESISTENZE AUSILIARIE	AUXILIARY HEATERS SWITCH
(x) IRAUX.	1	INTERRUTTORE RESISTENZE AUSILIARIE	AUXILIARY HEATERS SWITCH
KA2.7	2	RELE' AUSILIARIO SEGNALAZIONE GUASTO CONTATTORE RESISTENZE	AUXILIARY RELAY FOR RESISTOR CONTACTOR FAILURE
KA4.7	5	RELE' AUSILIARIO	AUXILIARY RELAY
KM2.4	2	CONTATTORE MOTORE POMPA NAFTA	OIL PUMP MOTOR CONTACTOR
KM2.8	2	CONTATTORE RESISTENZE PRERISCALDATORE [RP]	PRE-HEATING RESISTOR [RP] CONTACTOR
KM3.3	4	CONTATTORE MOTORE VENTILATORE	FAN MOTOR CONTACTOR
KT2.5	2	RELE' TEMPORIZZATORE	DELAYED RELAY
KTCN	3	RELE' AUSILIARIO CONSENSO NAFTA	OIL CONSENT AUXILIARY RELAY
KTRS	3	RELE' AUSILIARIO TERMOSTATO DI SICUREZZA	SAFETY THERMOSTAT AUXILIARY RELAY
LB	4	LAMPADA SEGNALAZIONE BLOCCO BRUCIATORE	INDICATOR LIGHT FOR BURNER LOCK-OUT
LEVA	4	LAMPADA SEGNALAZIONE APERTURA [EVA]	INDICATOR LIGHT FOR OPENING OF ELECTRO-VALVE [EVA]
LEVN	5	LAMPADA SEGNALAZIONE APERTURA [EVN]	INDICATOR LIGHT FOR OPENING OF ELECTRO-VALVE [EVN]
LEVP	4	LAMPADA SEGNALAZIONE APERTURA [EVP]	INDICATOR LIGHT FOR OPENING OF ELECTRO-VALVE [EVP]

(x)
 INSTALLATO SOLO SU ALCUNE VERSIONI
 INSTALLED ON ANY VERSIONS ONLY

Data	12/07/2012	PREC.	FOGLIO
Revisione	02	9	10
Dis. N.	07 - 0518	SEGUE	TOTALE
		11	12

Sigla / Item	Foglio / Sheet	Descrizione	Description
LF	5	LAMPADA SEGNALAZIONE FUNZIONAMENTO BRUCIATORE	INDICATOR LIGHT BURNER OPERATION
LF	5	LAMPADA SEGNALAZIONE FUNZIONAMENTO BRUCIATORE	INDICATOR LIGHT BURNER OPERATION
LMV20.100	4	APPARECCHIATURA DI COMANDO	CONTROL SCHEME
LP	2	LAMPADA SEGNALAZIONE FUNZIONAMENTO POMPA	INDICATOR LIGHT FOR PUMP OPERATION
LPAC	4	LAMPADA SEGNALAZIONE INTERVENTO PRESSOSTATO [PAC]	INDICATOR LIGHT FOR OPERATING PRESSURE SWITCH [PAC]
LPGP	5	LAMPADA SEGNALAZIONE PRESSOSTATO GAS PILOTA	INDICATOR LIGHT FOR PRESENCE OF GAS IN THE PILOT NETWORK
LRP	2	LAMPADA SEGNALAZIONE FUNZIONAMENTO PRERISCALDATORE [RP]	INDICATOR LIGHT FOR PRE-HEATING RESISTOR [RP] OPERATION
LT	2	LAMPADA SEGNALAZIONE BLOCCO TERMICO MOTORE VENTILATORE	INDICATOR LIGHT FOR FAN MOTOR OVERLOAD THERMAL CUTOUT
LTA	4	LAMPADA SEGNALAZIONE TRASFORMATORE DI ACCENSIONE	IGNITION TRANSFORMER INDICATOR LIGHT
LTCN	5	LAMPADA SEGNALAZIONE CONSENSO [KTCN]	INDICATOR LIGHT FOR [KTCN] CONSENT
LTP	2	LAMPADA SEGNALAZIONE BLOCCO TERMICO MOTORE POMPA	INDICATOR LIGHT FOR PUMP MOTOR OVERLOAD THERMAL CUTOUT
LTRS	2	LAMPADA SEGNALAZIONE BLOCCO TERMOSTATO DI SICUREZZA [TRS]	INDICATOR LIGHT FOR [TRS] SAFETY THERMOSTAT
MCX06C	3	REGOLATORE TEMPERATURE NAFTA	OIL TEMPERATURE REGULATOR
MP	1	MOTORE POMPA NAFTA	OIL PUMP MOTOR
MV	1	MOTORE VENTILATORE	FAN MOTOR
PA	4	PRESSOSTATO ARIA	AIR PRESSURE SWITCH
PAC	5	PRESSOSTATO ARIA DI POLVERIZZAZIONE	ATOMISATION AIR PRESSURE SWITCH
PGP	5	PRESSOSTATO PILOTA GAS	PILOT MINIMUM GAS PRESSURE SWITCH
PS	5	PULSANTE SBLOCCO FIAMMA	FLAME UNLOCK BUTTON
PT100	8	SONDA DI TEMPERATURA	TEMPERATURE PROBE
RA	1	RESISTENZE AUSILIARIE	AUXILIARY HEATERS
RP	1	RESISTENZE PRERISCALDATORE NAFTA	PRE-HEATING TANK RESISTORS
RWF40.0x0	7	REGOLATORE MODULANTE	BURNER MODULATOR
RWF50.2x	7	REGOLATORE MODULANTE (ALTERNATIVO)	BURNER MODULATOR (ALTERNATIVE)
S-EXIT	3	SONDA TEMPERATURA USCITA BARILOTTO	TANK OUTLET OIL TEMPERATURE PROBE
S-TCN	3	SONDA TEMPERATURA CONSENSO NAFTA	OIL CONSENT TEMPERATURE PROBE
S-TR	3	SONDA TEMPERATURA RESISTENZE	RESISTOR TEMPERATURE PROBE
SD-PRESS	8	SONDA DI PRESSIONE	PRESSURE PROBE
SD-TEMP.	8	SONDA DI TEMPERATURA	TEMPERATURE PROBE
SD - 0÷10V	8	TRASDUTTORE USCITA IN TENSIONE	TRANSDUCER VOLTAGE OUTPUT
SD - 4÷20mA	8	TRASDUTTORE USCITA IN CORRENTE	TRANSDUCER CURRENT OUTPUT
SQM3. AIR	6	SERVOCOMANDO SERRANDA ARIA	AIR DAMPER ACTUATOR
SQM3. FUEL	6	SERVOCOMANDO COMBUSTIBILE	FUEL ACTUATOR
ST	5	SERIE TERMOSTATI/PRESSOSTATI	SERIES OF THERMOSTATS OR PRESSURE SWITCHES
TA	4	TRASFORMATORE DI ACCENSIONE	IGNITION TRANSFORMER
TC	8	TERMOCOPPIA	THERMOCOUPLE
TP	1	TERMICO MOTORE POMPA	PUMP MOTOR THERMAL
TRAFO	3	TRASFORMATORE AUSILIARIO	AUXILIARY TRANSFORMER
TV	1	TERMICO MOTORE VENTILATORE	FAN MOTOR THERMAL

(x)

(x)
 INSTALLATO SOLO SU ALCUNE VERSIONI
 INSTALLED ON ANY VERSIONS ONLY

Data	12/07/2012	PREC.	FOGLIO
Revisione	02	10	11
Dis. N.	07 - 0518	SEGUE	TOTALE
		12	12

X03-03
 X03-05
 X06-03
 X04-02
 FREE
 X09-04
 X05-01

X56

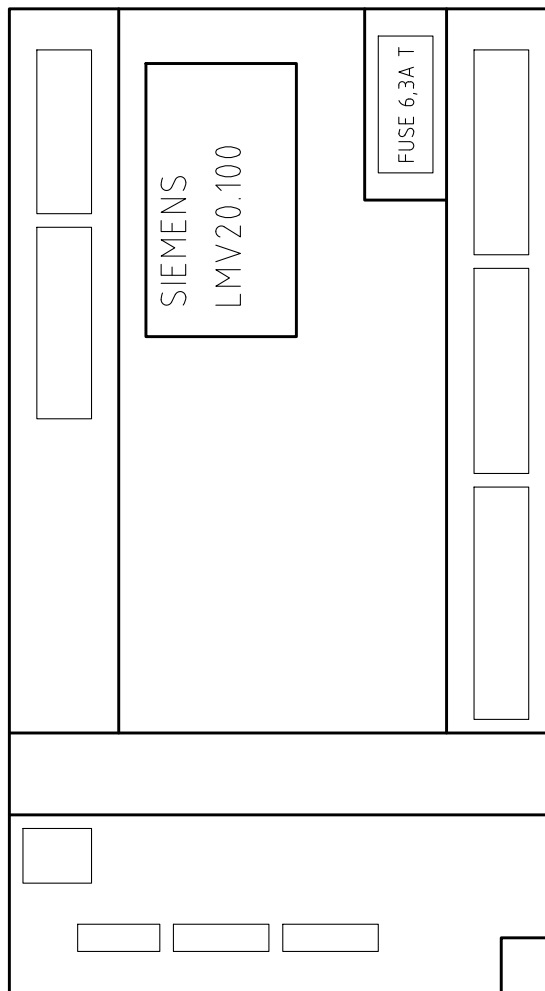

X03-04
 X07-01
 X08-02
 X08-04
 X05-03
 X03-02
 X10-06
 X10-05
 FREE

4	3	2	1	6	5	4	3	2	1	6	5	4	3	2	1
COM X92 RESERVE				X54						X53					

Data	12/07/2012	PREC.	FOGLIO
Revisione	02	11	12
Dis. N.	07 - 0518	SEGUE	TOTALE
	/		12